

$L > 4,1$ m

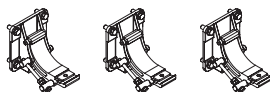

$L \leq 4,1$ m

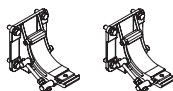

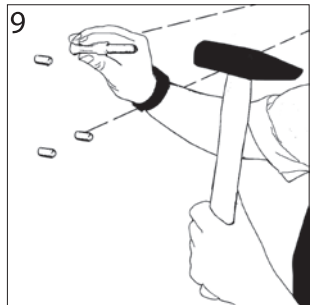
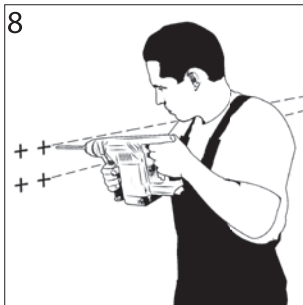
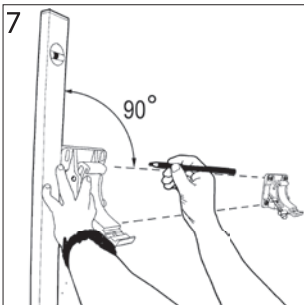
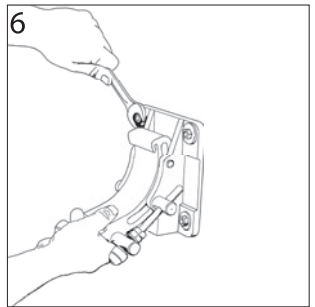
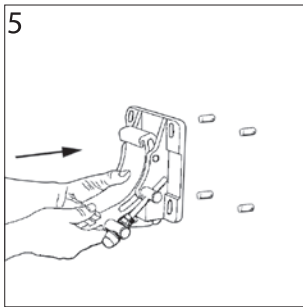
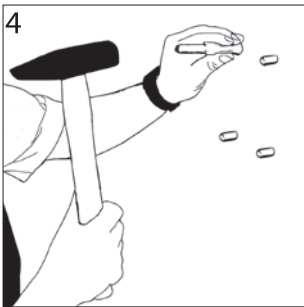
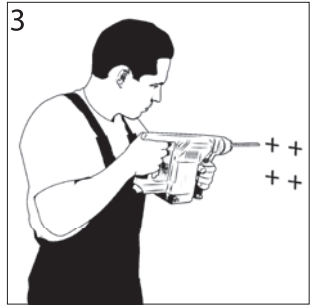
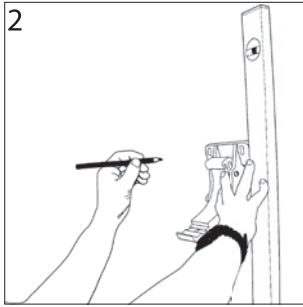
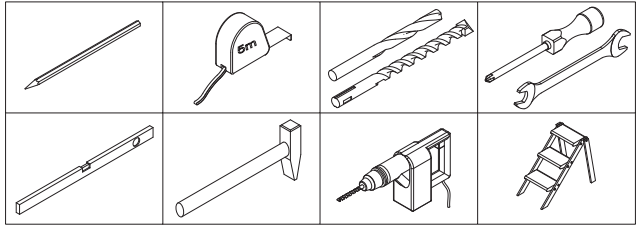

10

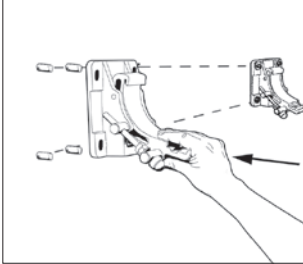

11

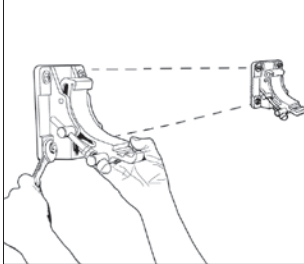

12



13

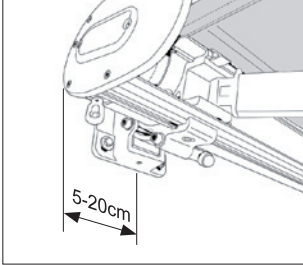

14

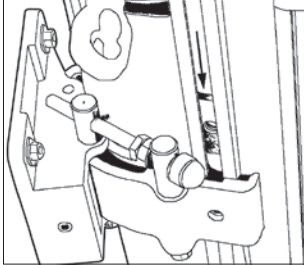

15

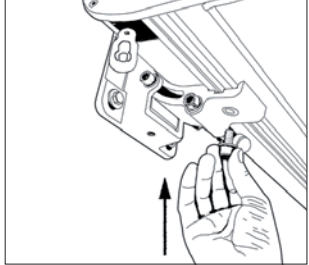

16

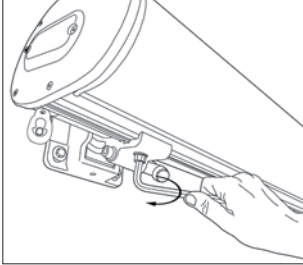

17

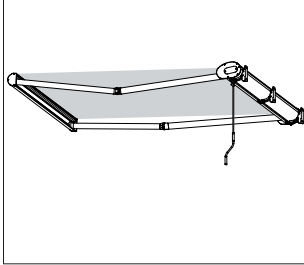

18

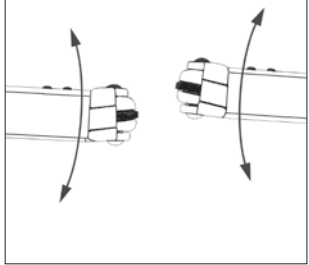

19



20

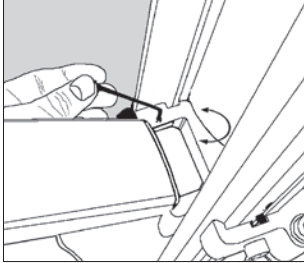

21

